

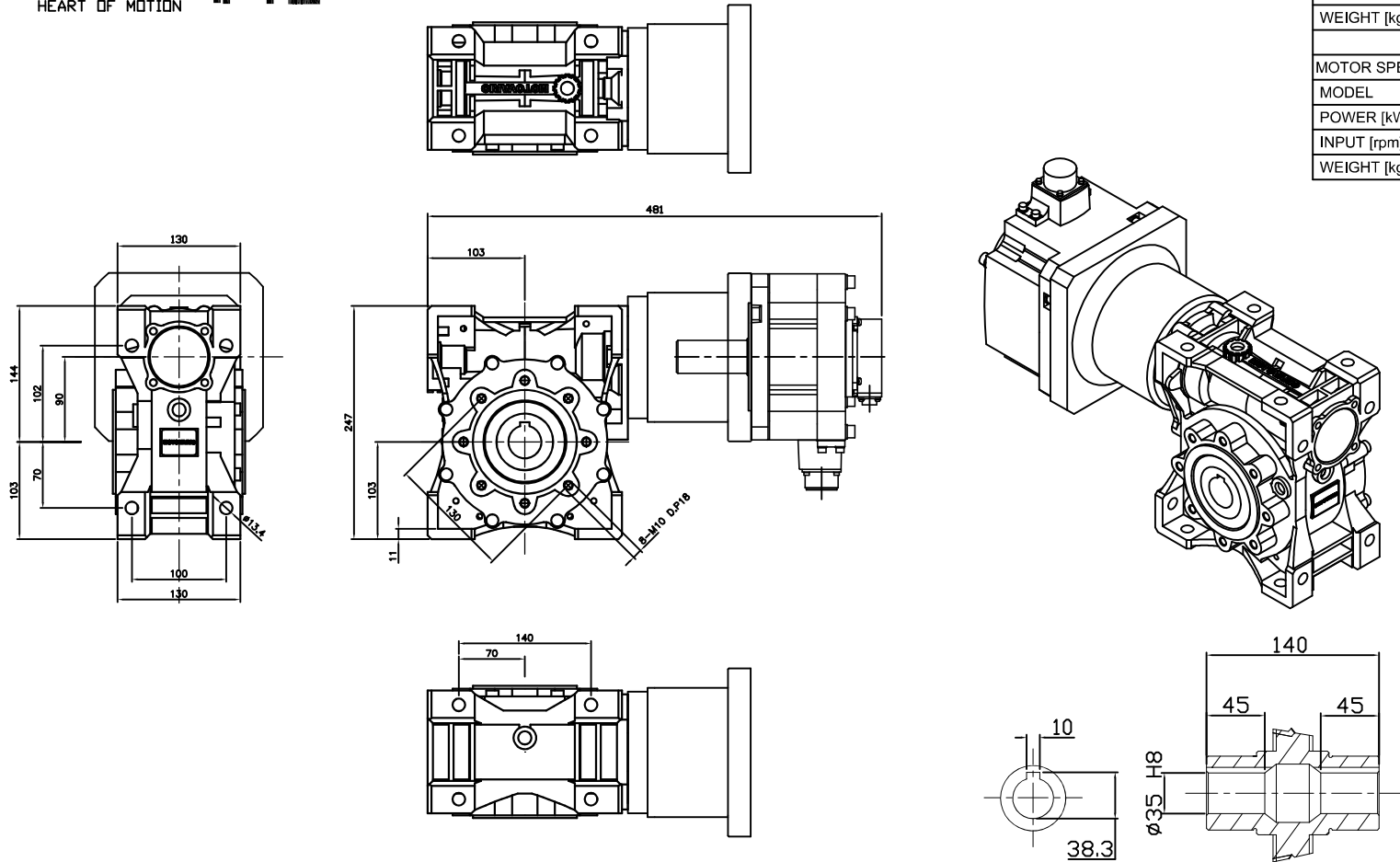

REDUCER SPEC	
MODEL	NMRV-P 090
SERVICE FACTOR	1.6
RATIO	25
OUTPUT [rpm]	80
OUTPUT TORQUE [Nm]	202.8
BACKLASH [arc-m]	6' - 18'
WEIGHT [kg]	13
MOTOR SPEC	
MODEL	HG-SR202
POWER [kW]	2
INPUT [rpm]	2000
WEIGHT [kg]	17



OUTPUT HOLLOW SHAFT

한국체인모터 (주)

Tel. 032-815-8888 Fax. 815-8020
www.hcmfa.com

PROJECT		MOTOVARIO					
DRAWN	SEO Y.S	DATE		REV	A	SCALE	1:1
CHECKED	KIM J.S	DATE		UNIT	MM	PAGE	-
APPROVED	LEE J.Y	DATE					