

NO	DESCRIPTION	MATERIAL	SIZE	DWG. NO	Q'TY	WT. (KG)		REMARK
						UNIT	TOTAL	

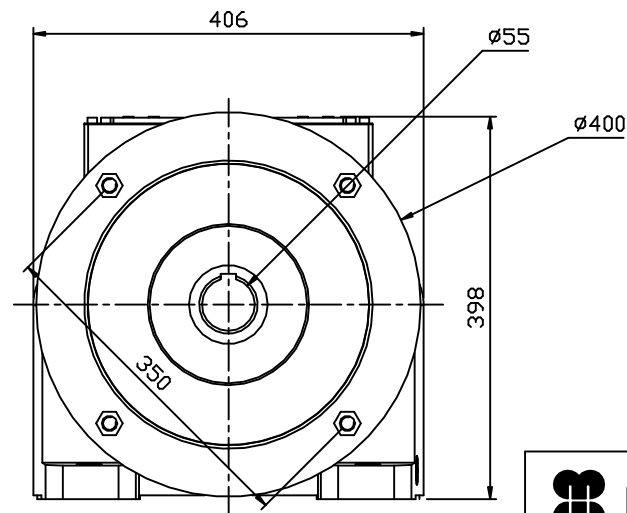

(주)한국체인모터
Tel. 032-810-0702 Fax. 815-8123

CUSTOMER APPROVE		AMEND		PROJECT		MOTOVARIO					
MECHANICAL	ELECTRICAL	△		MODEL		H122 200B5					
		△		MODEL NUMBER		HELICAL GEAR MOTOR					
		△		DRAWN	LEE M.P	DATE		REV	A	SCALE	NONE
		△		CHECKED	KIM J.S	DATE		UNIT	MM	PAGE	-
NO	CONTENT	DATE	APPROVED	LEE J.Y	DATE						

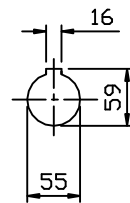
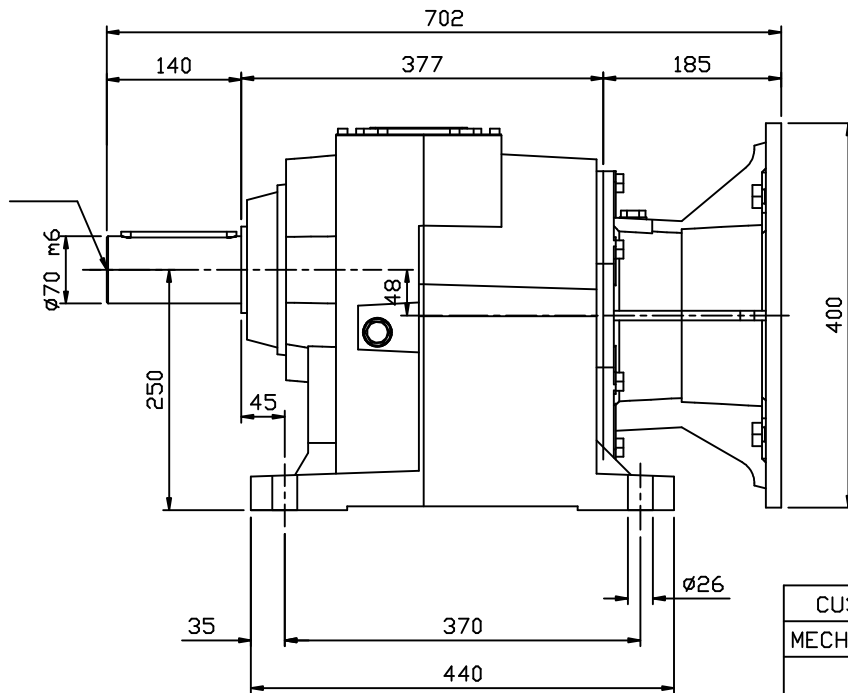
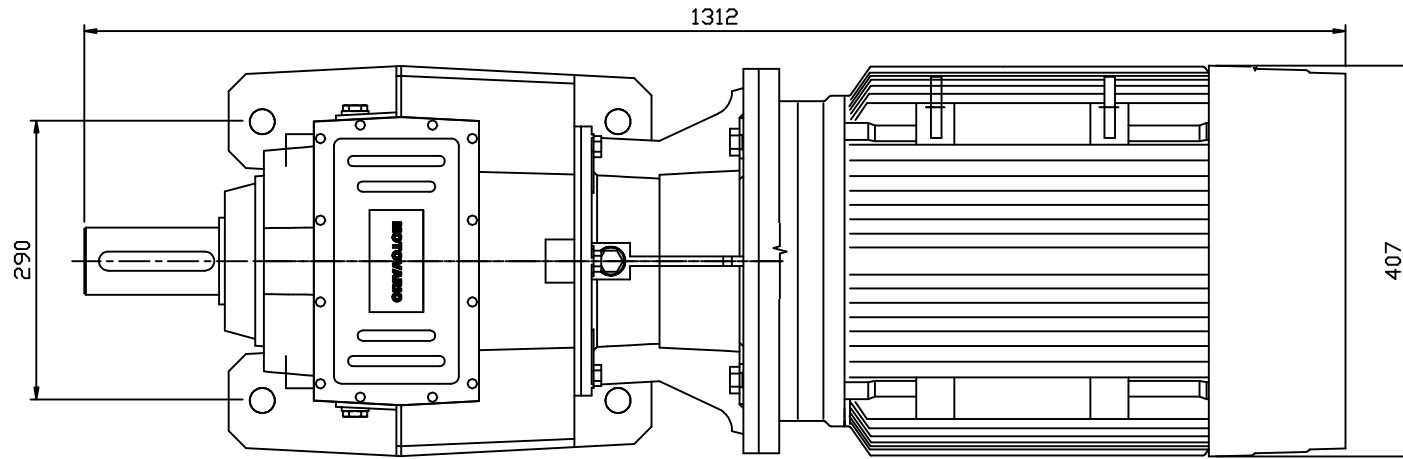