

PRODUCT DATASHEET

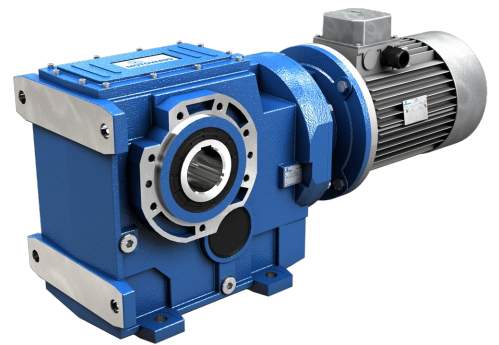

HELICAL BEVEL GEARED MOTOR WITH ACCESSORIES/MOTOR

DATE 17.05.2018

CONFIGURATION

CHARACTERISTIC	VALUE
Motor/Inverter Motor	With Motor
Regulations	No
Bevel Helical	PAM B
Size	143
Housing Version	U-Universal
Output Shaft Version	C-Hollow Shaft
Ratio (i)	105,83
Input Dim.	Ø300x38 (IEC132 B5)
Output Shaft Dim.	Ø70
ON-Oil Plugs	Breather-Drain-Level(Stand.)
Mounting Position	B3
Output Flange	No
Output Shaft	No
Torque Arm	No
ON-Output Oil Seal	NBR-Nitrile
ON-Input Oil Seal	NBR-Nitrile
ON-Lubrication	Eni Blasias 220
Paint	Ral 5010 Blue
Supplier	Motovario
Regulations	CE
Motor	Three-Phase
Size	132M
Series	High Efficiency
Poles	4
Electrical Execution	Std (Voltage Tolerance +/- 10%)
Service	S1
Voltage	220/380V
Frequency	50-60 Hz
Power	7,5 kW
Cooling	Self-Ventilated
Mounting Arrangements	B5
Terminal Box	Pos.1
Flange Dim.	Ø300
Shaft Dim. (DE)	Ø38x80
Rear Shaft End (NDE)	No
Insulation Rating	F
Protection Rating	IP55
Thermal Protectors	No
Ambient Conditions	Standard
Heaters	No

CHARACTERISTIC	VALUE
Condensation Drainage	No
Devices	No
Accessories	None
Terminal Box Cover	Aluminium
Fan	Plastic
Fan Cover	Standard
MO-Notes	No

Values expressed in [mm]

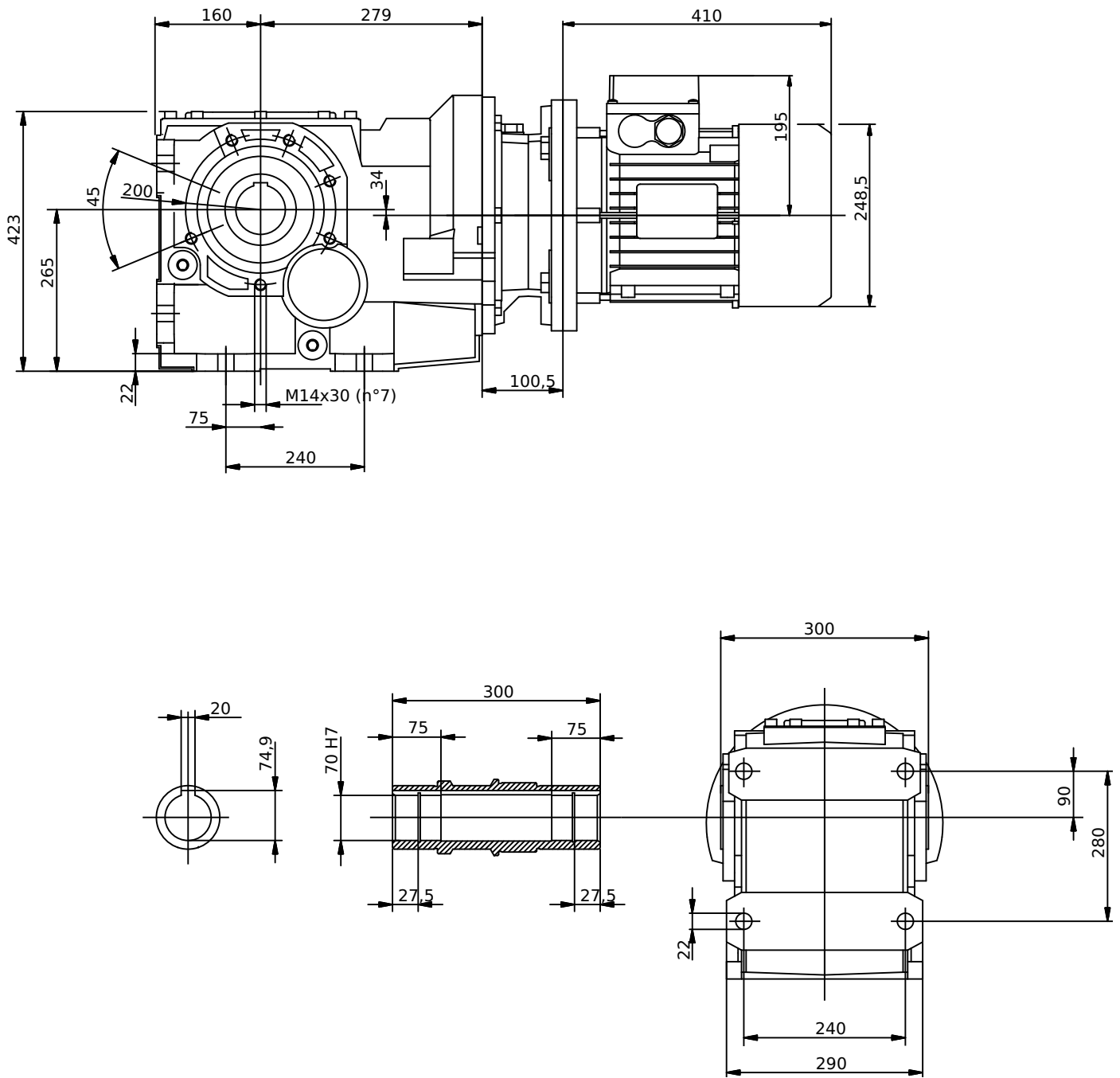

7,50 kW (50Hz)

n2 [rpm]	M2 [Nm]	fs	i	Gear reducer	Motor	Fr2 D-S-P [N]	Fr2 C [N]
13,8	4673	1,1	105,83	B143	TH132MA4	37603	37603

7,50 kW (60Hz)

n2 [rpm]	M2 [Nm]	fs	i	Gear reducer	Motor	Fr2 D-S-P [N]	Fr2 C [N]
16,6	3876	1,2	105,83	B143	TH132MA4	37003	37003

MOUNTING POSITIONS

The mounting position of the gear unit identifies its space orientation. B3 mounting position, as from a technical point of view, ensures lower oil splash, better lubrication and less heating.

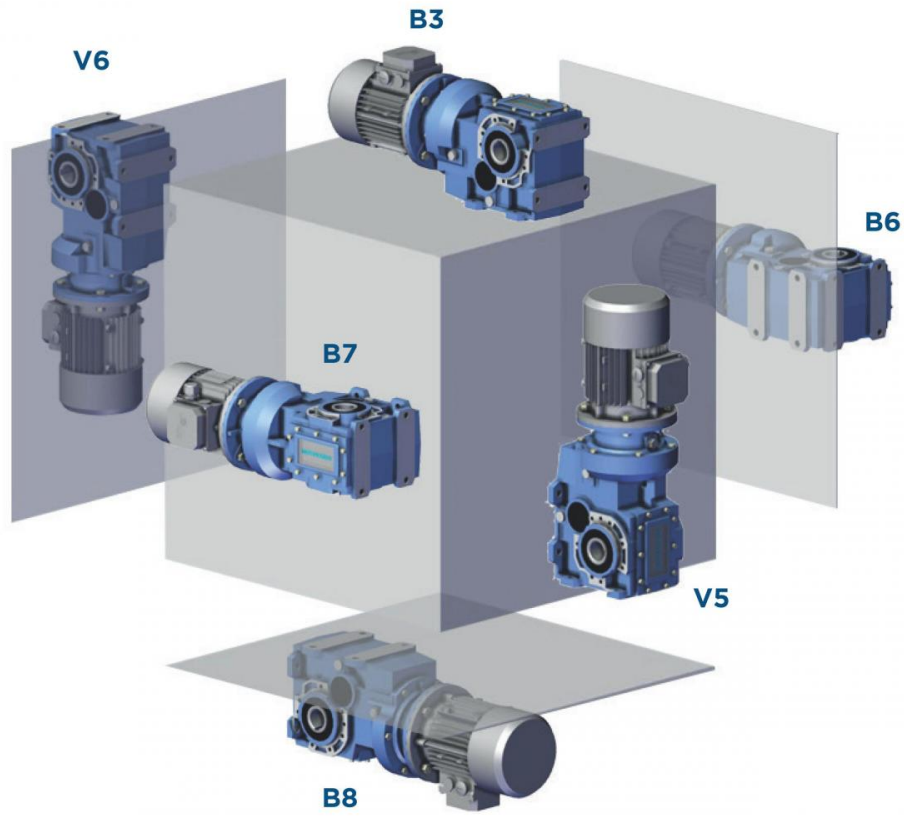

- For the reduction units B series it is always necessary to specify the mounting position.
- The reduction units BA.. series with 2, 3 stages and B060, are supplied complete with lubricant, have no oil plugs and need no maintenance.
- The gear reducer B series sizes 080, 100, 125, 140, 150, 160 are supplied complete with lubricant and are fitted with oil plugs to suit any mounting position included in the catalogue.

It is recommended, after installation, to replace the closed plug used for transportation with the supplied breather plug. Oil quantity in the table (litres -) are indicative; for a proper use you will have to refer to the level plug or the dipstick. Any level difference could depend on construction tolerances, but also by the placement of the unit or by the mounting surface at the customer's premises. It is appropriate to check and, if necessary, restores the level when the units are installed.

B	A42	A52	A53	A72	A73
B3	0,33	0,42	0,63	1	1,21
B8					
B6/B7					
V5					
V6					

CB	A42	A52	A53	A72	A73
B3	0,33	0,42	0,55	1	1,13
B8					
B6/B7					
V5					
V6					

B-CB	063	083	103	123	143	153	163
B3	1,2	2,5	3,7	5,7	11,1	19	33
B8	1,5	2,8	4,2	7,9	13	17,5	42,8
B6	1,5	3,5	6	8,5	14,5	26	43
B7	1,5	2,8	3,9	7,3	11,8	19	30
V5	2,1	3,7	7	9,9	18,5	32,5	54,5
V6	1,3	2,6	4,5	6,7	10,8	16,5	37,3

Helical bevel reduction units are supplied as “standard” with rotation as shown in the diagram. On request, the direction of rotation of low speed shaft can be reversed; in this case, it is necessary to specify “opposite rotation to catalogue” when ordering. The “opposite rotation to catalogue” is not possible for sizes BA42 - BA52 - BA53.

DIRECTION OF ROTATION - HIGH SPEED SHAFT

B-CB-IB A42-A52-A72

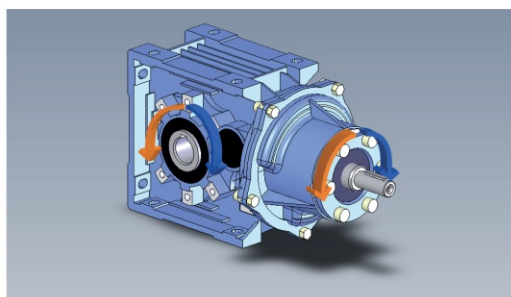

VERSIONS C-D-P-L

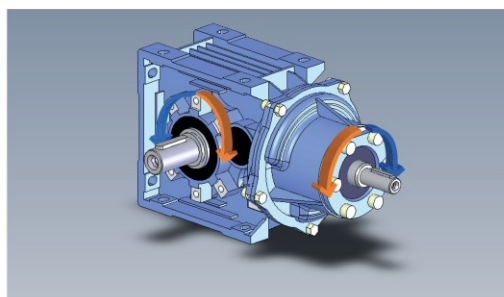

VERSION S

B-CB-IB A53-A73

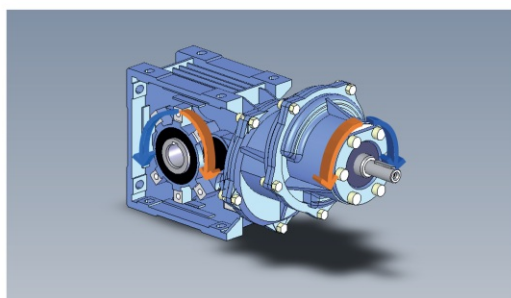

VERSIONS C-D-P-L

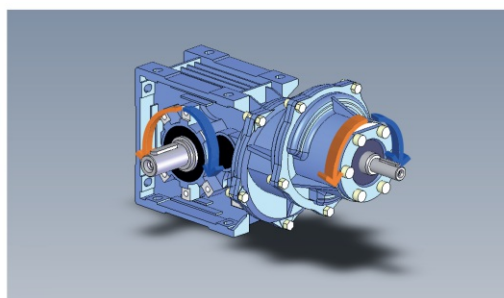

VERSION S

B-PB-CB-IB 063-163

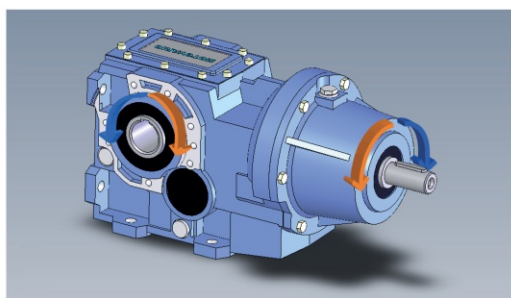

VERSIONS C-D-P-L

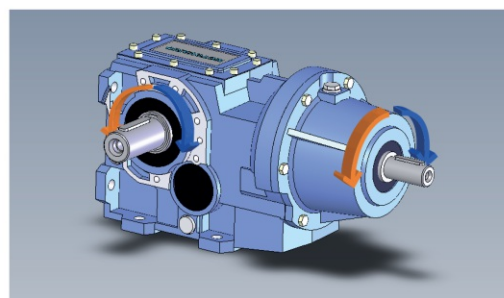

VERSION S-M